



10 AiR
Ten Years of the
Arts Institute's
Artist-in-Residence
Programme
2004 – 2014

10 AiR

Ten Years of the

Arts Institute's

Artist-in-Residence

Programme

2004 — 2014

Contents

Introduction 6–9

About the AiR programme 10–45

Past participating artists 46–73

Residency locations 74–79

1. Introduction

This publication is released to coincide with the tenth year of the existence of the Arts Institute's Artist-in-Residence (AiR) programme. Its purpose is to offer a qualitative and quantitative overview of the programme's impact on the arts in the Czech Republic.

The residency programme offers and coordinates residencies for artists working in the arts. The programme has run since 2004 and it is designed to promote international collaboration and communication and most of all to provide artists with time and space to engage in creative work and pursue inspiration without interruption. It provides Czech artists with the opportunity to travel abroad, while on the Czech side the Arts Institute in Prague attends to visiting artists accepted into the programme, which includes providing them with local contacts. The international Czech Centres have also become much more involved in helping to arrange residencies for artists abroad. The residency programme constitutes an active response to the acute need for subsidised residencies and work exchanges in the arts

community. There is a great interest in international residencies among artists. The programme is thus a source of targeted support for the development of creative work. Each year the programme invites applications for creative residencies in every branch of the arts – fine art, photography, literature, music, theatre, and dance. Once all the applications have been submitted, expert committees for each field of the arts are set up that comprise professionals from the given field (e.g. art theorists, university professors, artists, critics), and they select or recommend to partner organisations the best candidate or candidates for the creative arts residencies.

Bilateral exchanges have proved to be the most effective form of residency arrangement from an artistic and economic perspective: both partner organisations are responsible for the selection of artists and share in the expenses. One organisation sends an artist to a partner institution and in exchange receives a supported artist on residency from abroad. A very important role in this is the assistance provided by the host institution in establishing contacts in the local cultural and arts community for artists in the programme. This collaboration is of fundamental value for helping the artists to gain

an orientation in a new environment and to pursue their work in the country of their residency.

The Arts Institute has long collaborated with several centres in the Czech Republic that offer creative residencies, most notably MeetFactory and Futura Gallery in Prague. Both these organisations arrange their own arts residencies and consequently have experience and the necessary infrastructure to receive artists in the bilateral exchanges arranged between the Arts Institute and partner organisations abroad.

In addition to the residency programme in support of international cooperation, since 2004 the Arts Institute has been organising residencies at the Egon Schiele Art Centre (ESAC) in Český Krumlov which are intended specifically for visual artists. Each year eight to twelve Czech artists take part in one- to two-month residencies there. According to the final reports submitted by the artists at the end of their residency, for most of them the time at ESAC in Český Krumlov is inspiring and helps them to engage more effectively in creative work.

The Artist-in-Residence programme is primarily intended as a service to artists. It is extremely flexible, responds to current circumstances, allows the participation of students in the final year of study at an arts academy, and favours short-term residencies (two to three months as opposed to the six months or year required by the Ministry of Culture of the Czech Republic).

As an intermediary, the Arts Institute actively seeks partners at home and abroad through long-term contacts, holds competitions for arts residencies abroad, organises workshops for artists from abroad in the Czech Republic, and provides services to the Czech and foreign artists selected to participate in the programme.

Between 2004 and 2014 more than 200 creative residencies were organised in which 176 Czech and foreign artists took part.

Markéta Černá

2. About the AiR programme

In 2004 the Department of Arts and Libraries of the Ministry of Culture of the Czech Republic assigned the Theatre Institute with the function of acting as the coordinator of the new Artist-in-Residence programme for young artists in response to an acute need for international communication and exchanges for Czech artists active in various fields of the arts. Since 2005 the Artist-in-Residence programme has been coordinated by the Arts Institute.

The AiR programme is devoted to organising and coordinating exchanges for artists. It seeks to engage Czech artists in international collaboration in various branches of the arts. As well as sending Czech artists abroad, the Arts Institute also attends to visiting artists accepted into the programme, a task that includes arranging contacts for them in the Czech arts scene. The Arts Institute is a member of the ResArtis association, the worldwide network of artist residencies and creative residency programmes.

Number of creative residencies offered in 2004 – 2014

232

Number of creative residencies taken up in 2004 – 2014

211

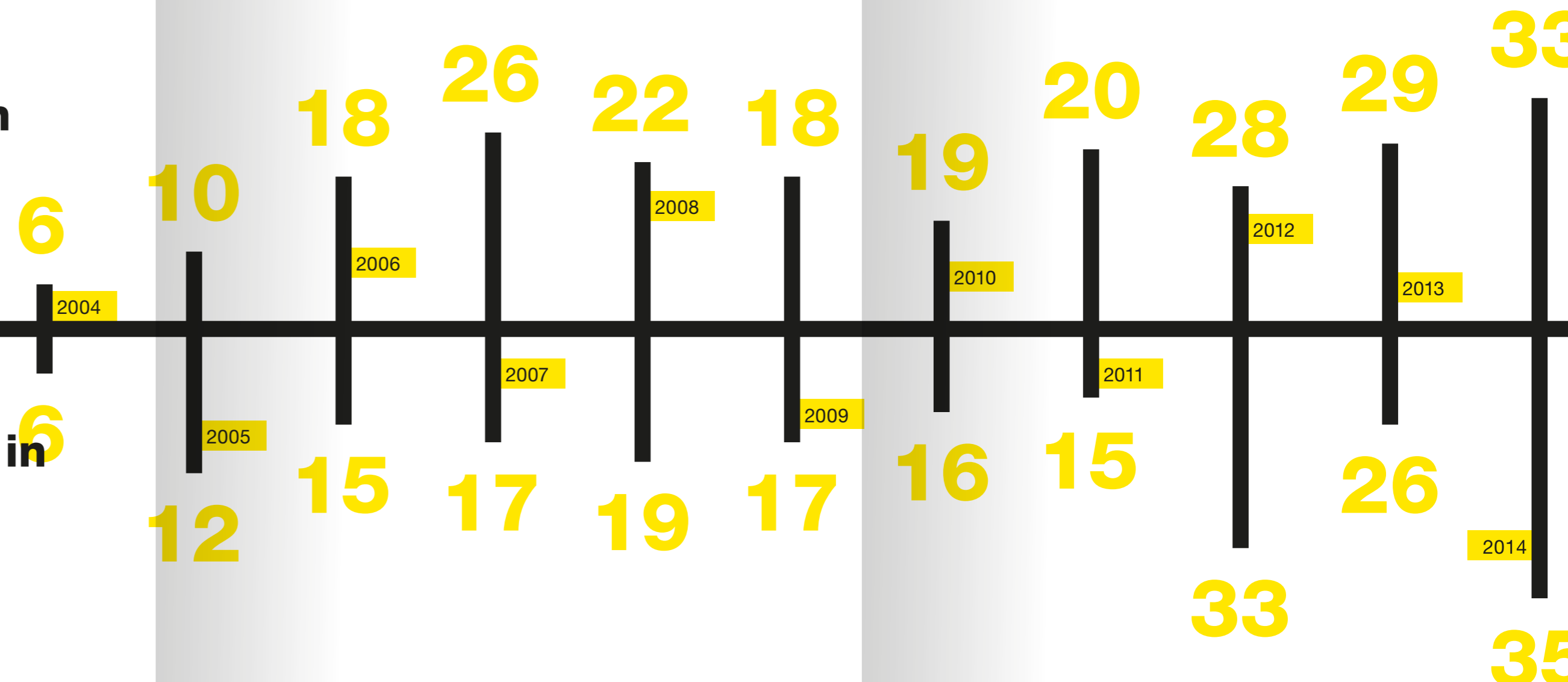

Creative residencies

2004 – 2014

by field

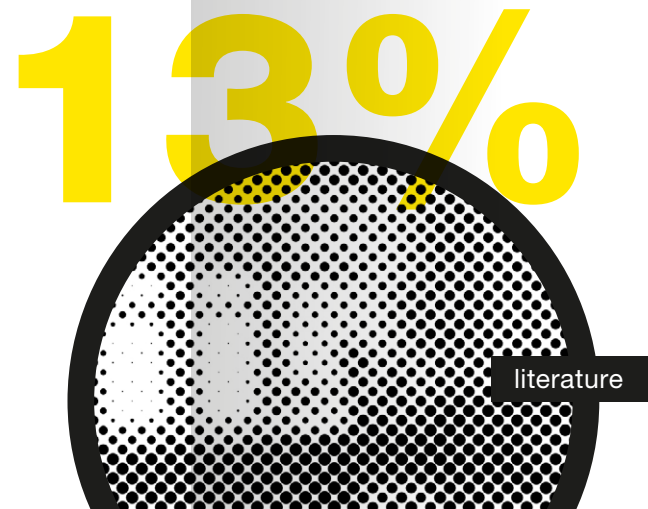
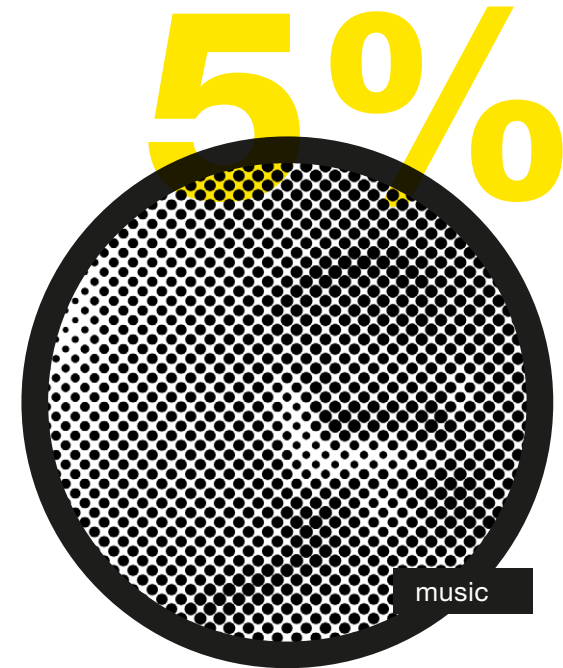
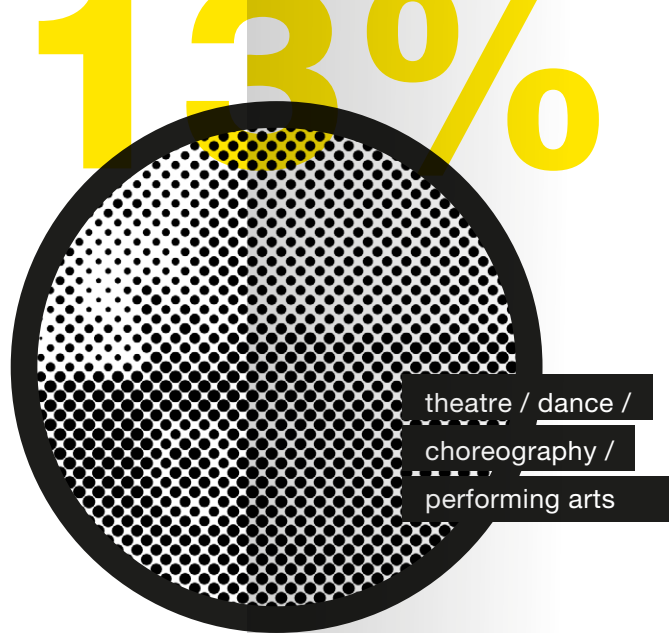
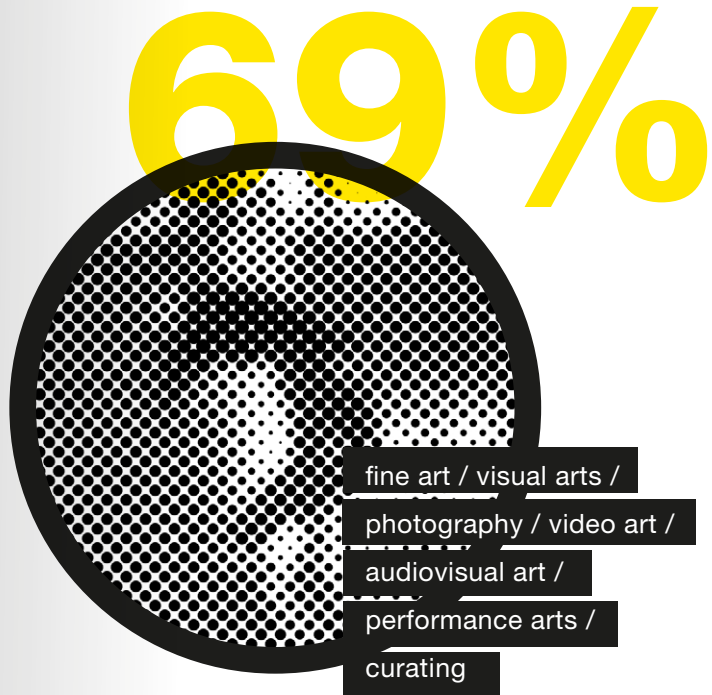

**Funding (in CZK)
awarded in support of
creative residencies
2004 – 2014***

6

2004 / 350 000

2005 / 500 000

2006 / 500 000

2007 / 500 000

2008 / 684 000

2009 / 530 000

2010 / 650 000

2011 / 680 000

2012 / 700 000

2013 / 680 000

2014 / 698 000

* The Arts Institute's Artist-in-Residence programme is funded by the Ministry of Culture of the Czech Republic.

Věra Ondrašíková

Barcelona / 2010

The aim of my work was to discover a specific form of movement and to disengage myself from my own 'stereotypical' movement structures. In creating a vocabulary of movement I focused on the possibilities of natural (intuitive) physical movement, an analysis of movement and its dynamics. On top of that, I busied myself with exploring new principles of choreographic composition and ways of arriving at powerful statements using a minimum of expressive devices ... In the process of my creative work I consulted with director Tomas Aragay on the alternatives of interpretation. At the close of my residency I had a solid idea about actual movement, stylisation, and working with expression. I also developed a clear idea of the sound components of a piece of work. The residency ended with a short presentation that put the material I'd learned to the test.

18 01

Marta Fišerová

Bucharest / 2014

I left for Bucharest fatigued by images of a full world ... But I was taken aback by a new vision – Bucharest and its streets, architecture, and boisterous urbanism. I rode through the city and everywhere I felt an atmosphere of motion and change. All this, mixed with a casual (perhaps?) almost raw combination of architectural styles, produced an unforgettable sensation in me that forced me to jump off my bike every ten metres to take a photograph.

02

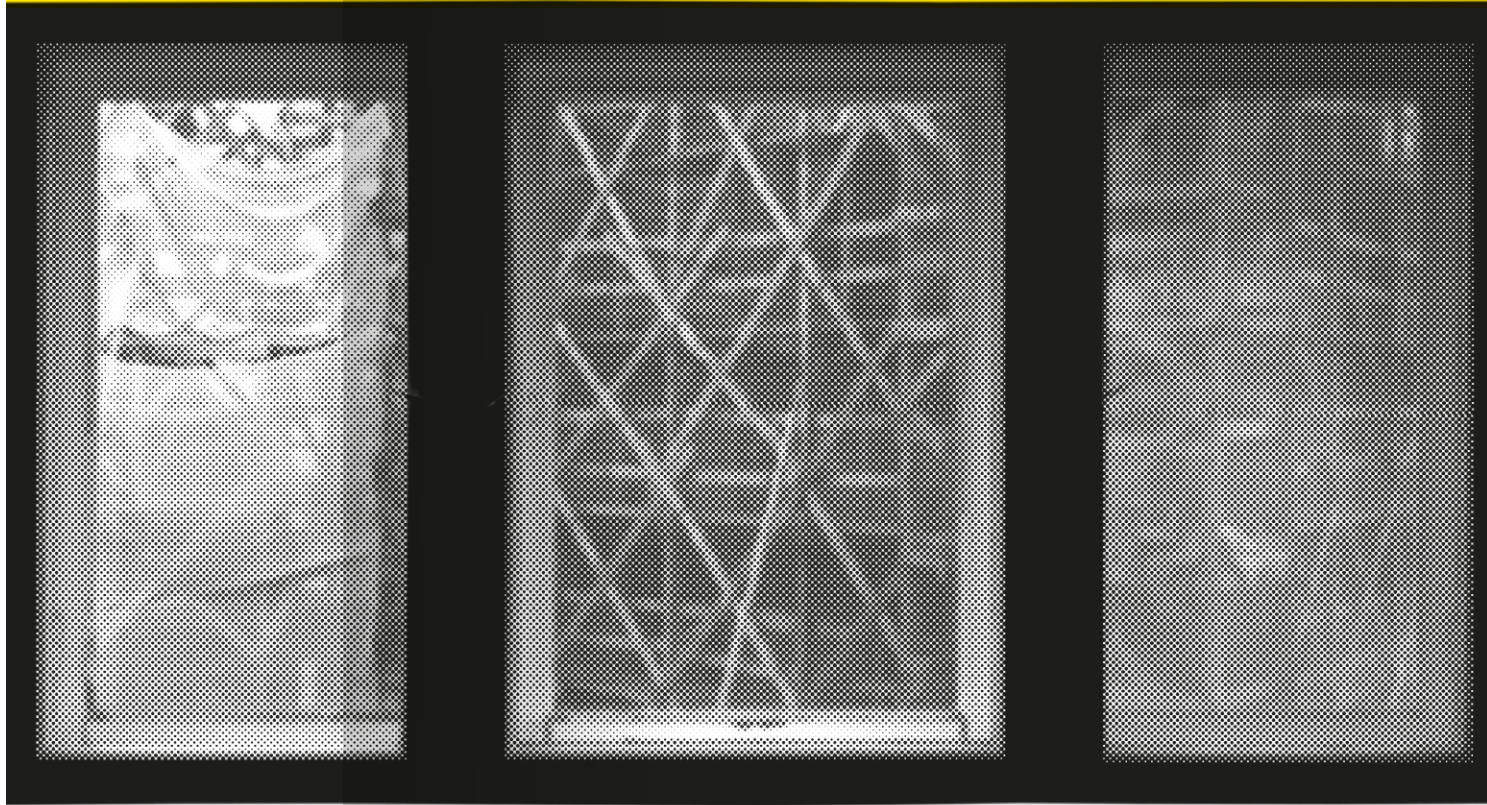

Viktor Čech

Liège / 2014

If I were to try to summarise the results of my one-month residency ... for me it was above all an opportunity to get to know a specific artistic and cultural environment, and in many respects my appreciation of its differences and unexpected parallels also enriched my perspective on other curatorial ideas open to me in the Czech context.

22 03

Jakub Hošek

New York / 2010

In September and October 2010 I had the opportunity to work in a creative environment in New York. I had truly long wanted to go to New York. I'd been trying for six whole years ... American contemporary art has been an inspiration for my work from the outset, so it was and is important to come face to face with the environment it comes from.

04

STŮL PRO ŠEFA

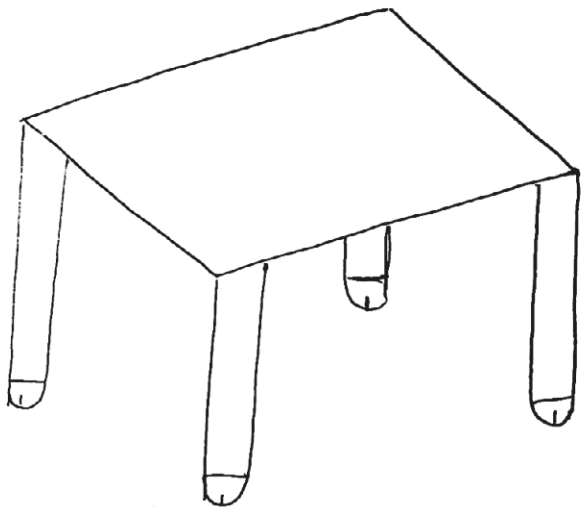

Radeq Brousil **Lisbon / 2009**

My residency in Lisbon was very nice and most definitely beneficial to my work. I would heartily recommend this particular residency to any artist for the great group at Club Portugues de Artes a Ideias. Collaboration with them exceeded my expectations and thanks to them I got to know the culture of a foreign city straightaway from several angles. They look after artists with care and respect and include them, if the artists want, in their activities.

26 **05**

Petr Kolečko **London / 2008**

First of all it has to be said that a residency at the Royal Court is a huge asset to any dramatic writer. In the Czech Republic only a tiny minority of people devote themselves to professional writing as their main profession. Despite an ongoing improvement in the situation, theatres perform very few original texts. For me the residency at the Royal Court was a unique opportunity to meet with authors who devote themselves full time to writing plays and for the first time ever to think intensively in a way about my playwriting.

06

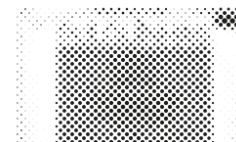
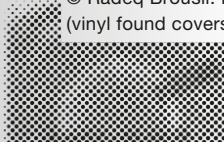
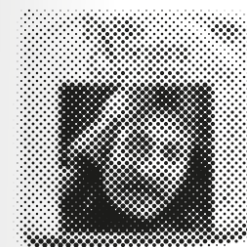
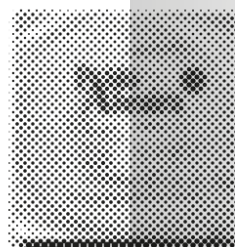
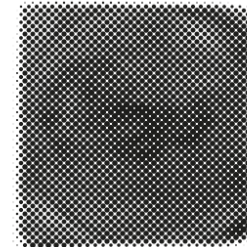
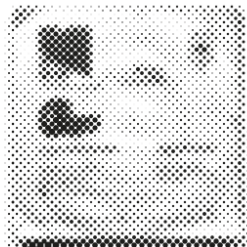
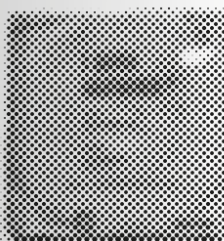
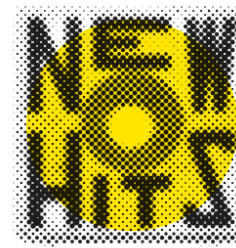
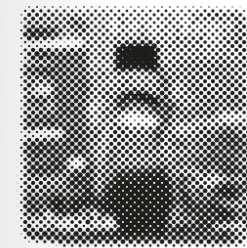
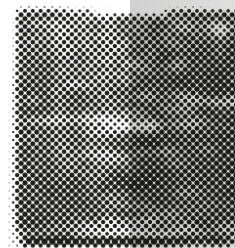
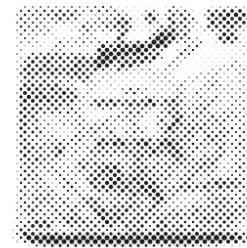
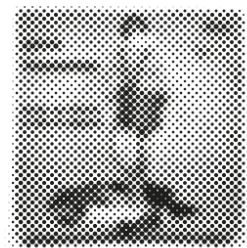
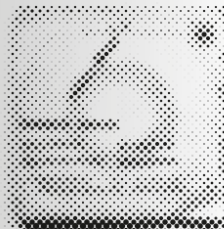
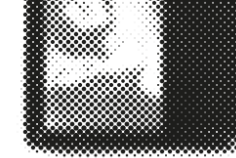
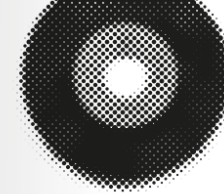
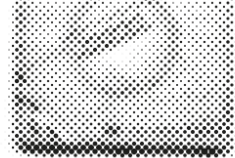
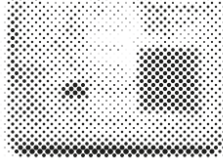

Igor Korpaczewski

Lisbon / 2007

My near one-month stay in Lisbon was an asset to me in many respects. The Portuguese national mentality, the product of a history full of extremes, a Mediterranean sensibility, and a fateful coexistence with the ocean, is the source of a specific artistic 'grasp' of life, which is manifested as a quite markedly strong relationship to literature and to language and what it has to offer – all this was passed on to me and was one of the most powerful experiences.

30 07

Radek Malý

Krakow / 2010

It confirmed for me that it isn't easy to write 'on command', so I can't say that I produced a ground-breaking number of new texts. I found the benefit of the residency, however, as lying elsewhere: in getting the chance to sort out for myself where I want my writing to go and why. Since this was the first time that I had the opportunity to truly create continuously and without interruption, in the end I mainly focused on translation ... Secondly I sorted out my 'writing drawer' – I turned poems created in my main stream of work and on the side over the last eight years into two short collections.

08

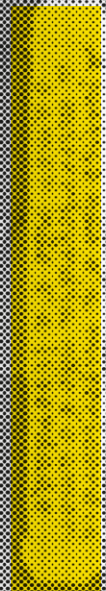

© Igor Korpaczewski:
Justice Isn't Mercy, Mercy Isn't Love,
Love Isn't Freedom, 2007

Tomáš Žižka

Rio de Janeiro /

Cataguases / 2005

I would like to express my thanks for the opportunity to be in an environment where theatre is still very much tied up with social conditions and society. Where it is still art's function to tackle everyday problems of insecurity and social conflicts in society ... An important factor was my presence at the Instituto Francisca de Souza Peixoto in the city of Cataguases, where I was invited to teach and assist in developing new programmes for this socio-cultural centre.

34 09

Jana Kochánková

Český Krumlov / 2009

During the second week I found inspiration in the darkness and the shadows of my apartment and studio, where after dark the orange glow of the streetlamps shone in and created shadows from the objects in the flat, from the furniture, and out of me myself. Every night before falling asleep I would gaze in fascination at those shadows. Until I decided to paint them.

10

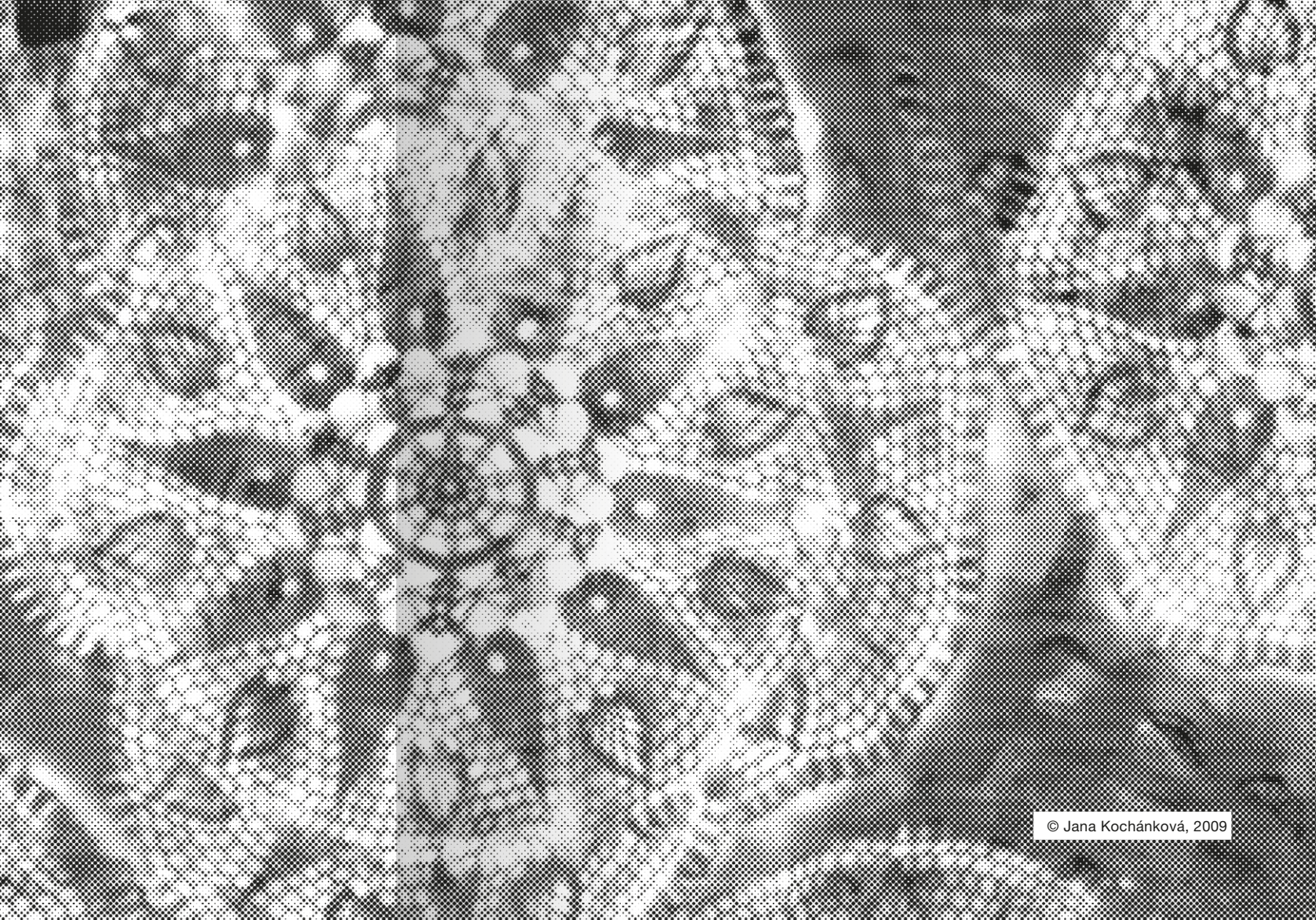
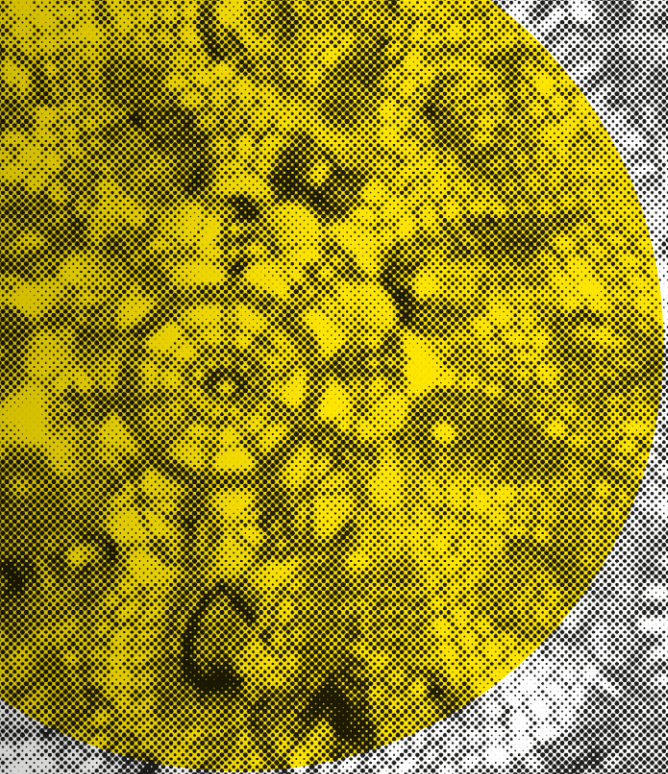

Ondřej Maleček

Český Krumlov / 2009

It was only some time later when I looked at the paintings I created in Krumlov that I discovered that they form a coherent cycle, that they are fragments that complete and support each other but also function entirely on their own. I was surprised how much the motif of the river made it into the paintings – the Vltava flowed below my studio window – without my having deliberately planned it. I really enjoyed my residency. I got to know other artists from Europe: Magna from Germany, who was engaged in performance art, Marcus from Vienna, who created site-specific work, and Zuza from Hungary, who was focusing on ceramic art. The town of Český Krumlov enthralled me. I enjoyed wandering through its surrounding areas.

Viktor Vejvoda

Český Krumlov / 2014

What inspired me to release an electronic album of the noises and conversations of the night was the atmosphere in Český Krumlov, resembling a depopulated ghetto and deserted town (above all during the workweek). On workdays it is hard to come across anyone other than tourists in the town. Its atmosphere of an open-air museum is then contrasted on Thursday, Friday and Saturday nights when the ‘City Lounge’, or disco, adjacent to the Czech studio of the Egon Schiele Art Centre opens. The sounds of loud music, taxis, fights, lovers’ quarrels, and other screeching noises notionally bring to life the human and cultural ambience of Český Krumlov.

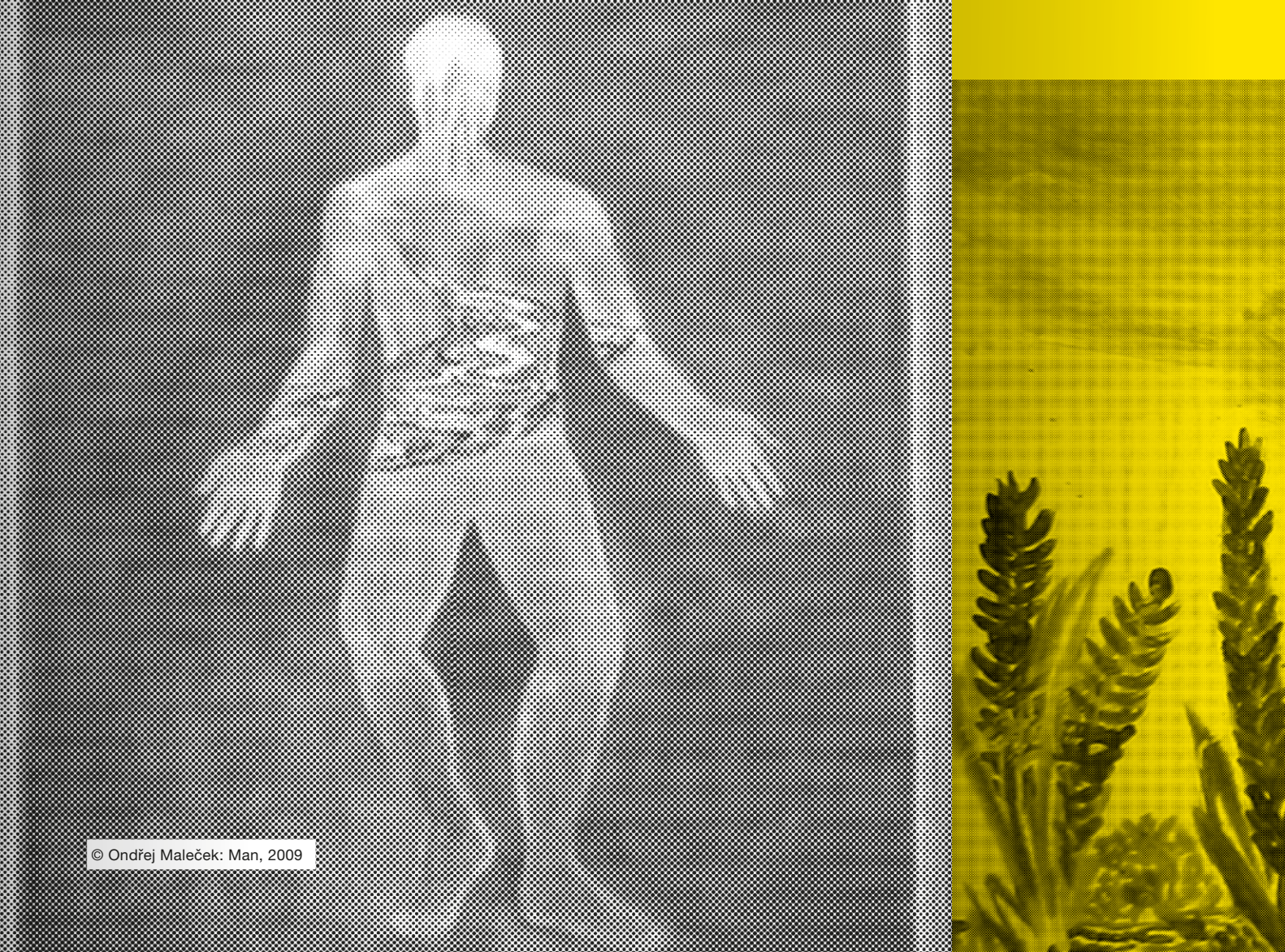

© Ondřej Maleček: Man, 2009



© Ondřej Maleček: Meadow, 2009

Martin Kubát

Český Krumlov / 2010

Krumlov in December proved ideal for my book. Fog, snow, a drowning canoeist being fished out of the river, tourists, tired demons, steamed-up eyeglasses for the first few minutes at a Gypsy wedding, guinea pigs, rubbish bins in the streets, a midnight exhibition opening at Ukradená Gallery in the presence of a burning barrel. The apartment and studio are beautiful.

42 **13**

David Böhm

Český Krumlov / 2014

I stayed shut up in the studio for several days without any stimuli that might distract me or connect me to the outside world (a watch, computer, music, books, the telephone) and where my only activity (except simple cooking) was drawing. Being able to focus my attention like this enabled me to look more deeply and differently at my work.

14

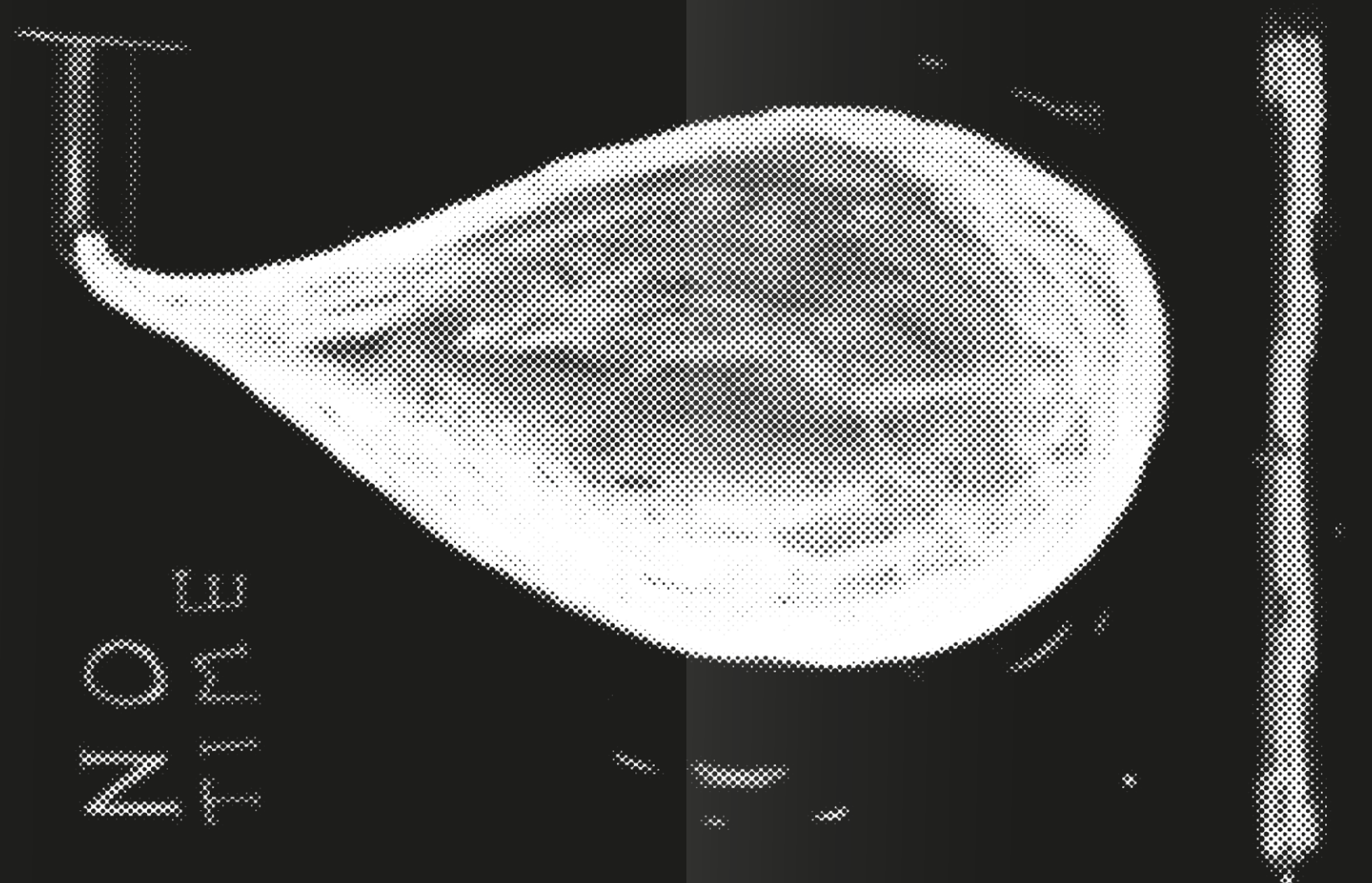

NOE
TIME

A map of residency locations 2004 – 2014

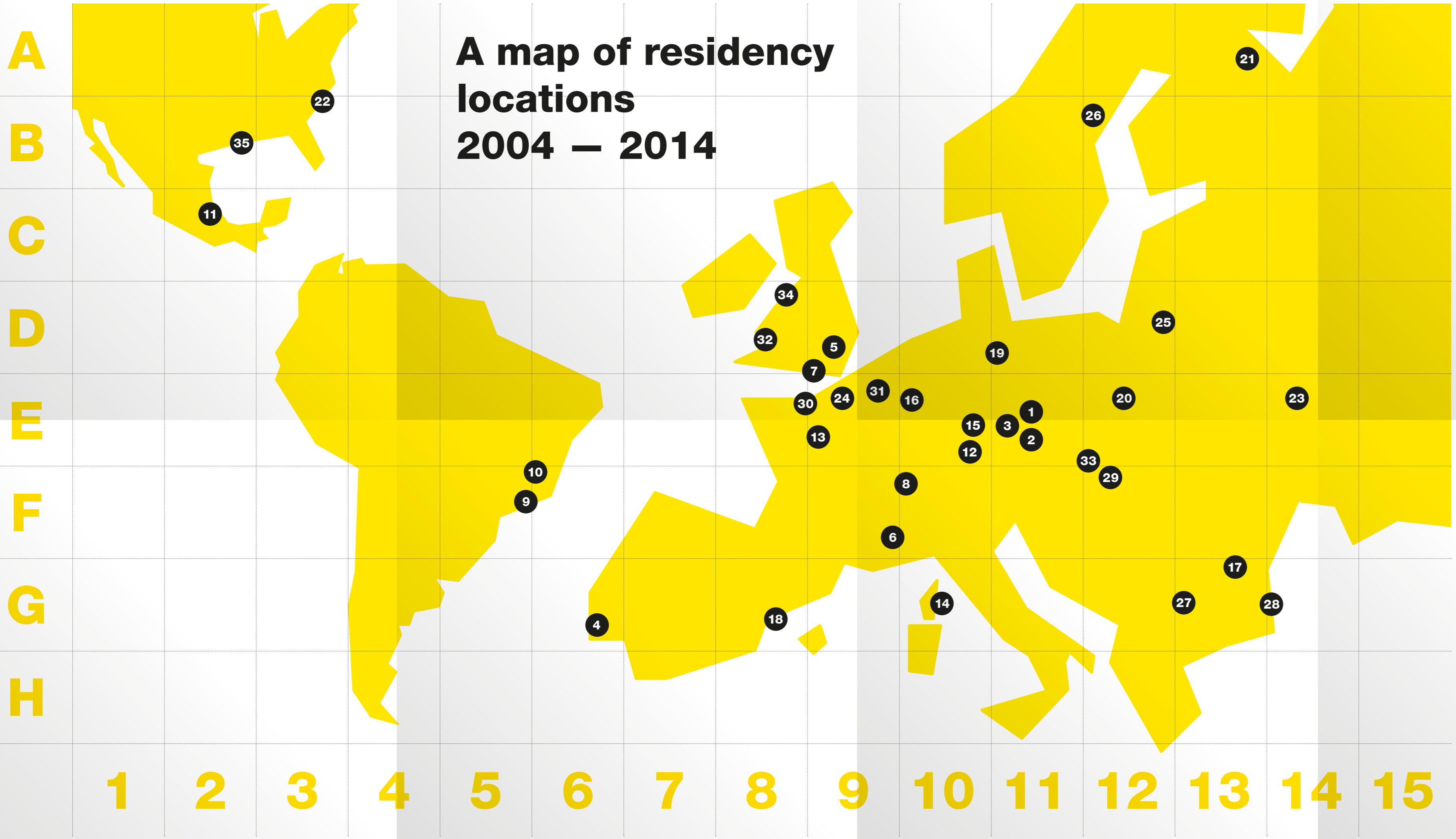

- 1 **Prague** 2004–2014 **E11**
- 2 **Český Krumlov** 2004–2014 **E11**
- 3 **Klenová** 2006, 2007 **E11**
- 4 **Lisbon** 2004–2010 **G6**
- 5 **London** 2004, 2008, 2010 **D9**
- 6 **Turin** 2004 **F9**
- 7 **Brighton** 2005 **D9**
- 8 **Bern** 2005, 2006, 2007 **F10**
- 9 **Rio de Janeiro** 2005, 2006 **F5**
- 10 **Cataguases** 2005 **F6**
- 11 **Mexico City** 2005–2014 **C2**
- 12 **Munich** 2006 **E10**
- 13 **Paris** 2006 **E9**
- 14 **Corsica** 2006 **G10**
- 15 **Freising** 2006, 2007 **E10**
- 16 **Wiesbaden** 2007, 2008, 2009 **E10**
- 17 **Bucharest** 2007, 2011–2014 **G13**
- 18 **Barcelona** 2008, 2009, 2010 **G8**
- 19 **Potsdam** 2008 **D11**
- 20 **Krakow** 2009, 2010 **E12**
- 21 **Jyväskylä** 2009, 2010 **A13**
- 22 **New York** 2010, 2011 **B3**
- 23 **Kyiv** 2011 **E14**
- 24 **Brussels** 2011–2014 **E9**
- 25 **Minsk** 2011 **D12**
- 26 **Stockholm** 2012 **B12**
- 27 **Sofia** 2012, 2013 **G13**
- 28 **Burgas** 2013 **G14**
- 29 **Budapest** 2013 **F12**
- 30 **Kortrijk** 2014 **E8**
- 31 **Liège** 2014 **E9**
- 32 **Aberystwyth** 2014 **D8**
- 33 **Bratislava** 2014 **E12**
- 34 **Liverpool** 2014 **D8**
- 35 **New Orleans** 2013 **B2**

3. Past Participants



A list of Czech artists and artists from abroad who participated in residencies at the Egon Schiele Art Centre in Český Krumlov 2004 – 2014

Alvær Jesper	2008	visual arts
Bárta Tomáš	2012	visual arts
Basjuk Ondřej	2014	visual arts
Baumann Eva /CH/	2005	visual arts
Böhm David	2014	visual arts
Bražina Martin	2014	visual arts
Brody Ondřej	2011	visual arts
Burget Michal	2004	visual arts
Cenek Filip	2007	visual arts
Czesaný Jonáš	2006	visual arts
Čermák Aleš	2011	visual arts
Čihařová Linda	2009	visual arts
Dirnerová Alžběta	2007	visual arts

Dub Petr	2010	visual arts
Egert Martin	2004	visual arts
Fryčová Monika	2010	visual arts / performance art
Gajdošíková Pavla	2010	visual arts
Gažiová Ladislava	2012	visual arts
Geltner Jakub	2012	visual arts
Grosseová Isabela	2008	visual arts
Hábl Patrik	2004	visual arts
Hájek Lukáš	2010	visual arts
Haubelt Jan	2009	visual arts
Havlíček Jiří	2012	visual arts / video art
Helán David	2011	visual arts
Herotová Petra	2011	visual arts
Heřmánková Karolína	2008	visual arts
Hladíková Marie	2006	visual arts
Hošek Pavel	2004	visual arts
Chovanec Jan	2009	visual arts
Jakubová Lenka	2010	visual arts

Jakubčíková Blanka	2006	visual arts
Kabůrková Tereza	2009	visual arts
Kačena Jan	2011	visual arts / theatre
Kasalová Jana	2009 / 2013	visual arts
Kindernay Michal	2011	visual arts / video art
Klímová Barbora	2005	visual arts
Klyukov Alexey	2012	visual arts
Kochánková Jana	2009	visual arts
Koníčková Tereza	2013	audiovisual arts
Kopecký Václav	2012	visual arts
Kotzmannová Alena	2005	photography
Kožíšek Petr	2005	visual arts
Krajc Martin	2011	visual arts
Krysl Michal	2005	visual arts
Kubát Martin	2010	visual arts
Kupyrová Nika	2010	visual arts
Lang Dominik	2010	visual arts
Lipus Matouš	2014	visual arts

Lisá Markéta	2009	visual arts
Lukáš Pavel	2008	visual arts
Maleček Ondřej	2009	visual arts
Markvartová Iva	2004 / 2006	visual arts
Morys Oldřich	2012	visual arts
Mráčková Markéta	2014	visual arts / literature
Nikitinová Alice	2005	visual arts
Novák Vilém	2010	visual arts
Novotný Libor	2009	visual arts
Oplatková Hanka	2009	visual arts
Perglerová Eliška	2014	visual arts
Pěchouček Michal	2006	visual arts
Podzemná Marcela	2004	visual arts
Příhodová Tereza	2014	visual arts
Rous Janek	2012	visual arts
Řezáčová Zdeňka	2005	visual arts
Římalová Petra	2012	visual arts
Samohejl Rudolf	2013	visual arts

Sedlecký Zbyněk	2007	visual arts
Sikora Erik /SK/	2011	visual arts
Skálová Alžběta	2010	visual arts
Sochorová Tereza	2009	visual arts
Soukup Štěpán	2014	visual arts
Sterec Pavel	2011	visual arts
Szanyi Hudečková Katarína	2008	visual arts
Šalanda Robert	2008	visual arts
Šimonová Barbora	2014	visual arts / literature
Šlajs David	2008	visual arts
Šrámek Jan	2012	audiovisual arts
Štekrová Andrea	2009	visual arts
Štětina Roman	2012	visual arts / video art
Švarcová Barbora	2012	visual arts
Takáč Viktor	2013	visual arts / video art
Taübelová Adéla	2014	visual arts / performance art
Ther Mark	2007	visual arts
Thýn Jiří	2012	visual arts

Tichoň Pavel	2007	visual arts
Trnobranský Tomáš	2004	visual arts
Tůma Radek	2008	visual arts
Varadiová Markéta	2004	visual arts
Večeřová Miroslava	2014	visual arts
Vejvoda Viktor	2014	visual arts
Velková Zorka	2008	visual arts
Viegas Mariana /PT/	2004	photography
Viček Daniel	2014	visual arts
Winklerová Diana	2012	visual arts
Zemková Kamila	2013	visual arts
Zochová Kateřina	2009	visual arts
Žalio Jan	2013	visual arts



A list of Czech artists who participated in residencies abroad and in the Czech Republic 2004 – 2014

Alt Hynek FONCA Conaculta / El Centro de la Imagen Mexico City /MX/ 2011 - visual arts, photography

Andřlová Alena Schafhof Freising /DE/ 2006 - visual arts

Artamonov Vasil Czech Centre Moscow /RU/ 2012 - visual arts

Babincová Jana Schafhof Freising /DE/ 2007 - visual arts

Baladrán Zbyněk PROGR/Zentrum für Kulturproduktion Bern /CH/ 2007 - visual arts

Bartůňková Lenka M.O.M. / el vivero / Area Tangent Barcelona /ES/ 2008 - dance

Benýšek Zbyněk Czech Centre Sophia /BG/ 2012 - literature

Boháč Petr Czech Centre Brussels / Les Brigittines /BE/ 2014 - choreography, dance

Bolf Josef Schafhof Freising /DE/ 2006 - visual arts

Boučková Tereza Villa Clementine Wiesbaden /DE/ 2008 - literature

Brabcová Petra Club Portugues de Artes e Ideias Lisbon / Lugar Comum Barcarena /PT/ 2005 - dance

Brody Ondřej PROGR/Zentrum für Kulturproduktion Bern /CH/ 2006 - visual arts

Brousil Radeq Club Portugues de Artes e Ideias Lisbon / Lugar Comum Barcarena /PT/ 2009 - visual arts; Czech Centre Brussels / T.A.G. Gallery Brussels /BE/ 2011 - visual arts

Ctibor Pavel Logvinov Minsk /BY/ 2011 - literature

Czesaný Jonáš Schafhof Freising /DE/ 2007 - visual arts

Čech Viktor RAVI Liège /BE/ 2014 - visual arts, curating

Čechová Miřenka Czech Centre Brussels / Les Brigittines /BE/ 2014 - dance

Čichoň Petr Villa Clementine Wiesbaden /DE/ 2008 - literature

Čumba Ladislav Villa Decius Krakow /PL/ 2009 - literature

Danelová Michaela Czech Centre Bucharest /RO/ 2011 - visual arts

David Milan FONCA Conaculta / Centro Nacional de las Artes / Escuela Nacional de Arte Teatral Mexico City /MX/ 2005 - theatre, visual arts

Denemarková Radka Villa Clementine Wiesbaden /DE/ 2007

- literature

Doležálková Klára M.O.M. / el vivero / Area Tangent Barcelona /ES/

2009 - visual arts

Fišerová Marta Czech Centre Bucharest /RO/ 2014 - visual arts

Fišerová Tereza Czech Centre Brussels - PianoFabriek

Brussels /BE/ 2014 - audiovisual arts, video art

Fridrich Radek Villa Clementine Wiesbaden /DE/ 2009, 2010

- literature

Gažiová Ladislava Czech Centre Bucharest /RO/ 2013

- visual arts, photography

Gregorová Barbora Czech Centre Kiev /UA/ 2011 - literature

Grosseová Isabela Castello Reale di Racconigi Torino /IT/ 2004

- visual arts; FONCA Conaculta / Escuela Nacional de Pintura,

Escultura y Grabado 'La Esmeralda' Mexico City /MX/ 2006 -

visual arts

Hájek Jiří Club Portugues de Artes e Ideias Lisbon / Lugar

Comum Barcarena /PT/ 2004 - music

Haubelt Jan FUTURA - center for contemporary arts / ISCP

New York /US/ 2011 - visual arts

Hauerová Petra Club Portugues de Artes e Ideias Lisbon / Lugar

Comum Barcarena /PT/ 2005 - dance

Hauerová Zuzana Club Portugues de Artes e Ideias Lisbon /

Lugar Comum Barcarena /PT/ 2005 - dance

Helán David Czech Centre Bucharest /RO/ 2014 - visual arts

Heřman Jiří Club Portugues de Artes e Ideias Lisbon / Lugar

Comum Barcarena /PT/ 2004 - music

Holý Adam FONCA Conaculta / El Centro de la Imagen Mexico

City /MX/ 2010 - photography

Horoščák Marek Royal Court Theatre London /UK/ 2010

- theatre, literature

Hošek Jakub PROGR/Zentrum für Kulturproduktion Bern /CH/

2006 - visual arts; FUTURA - center for contemporary arts / ISCP

New York /US/ 2010 - visual arts

Hrůza Tomáš Club Portugues de Artes e Ideias Lisbon / Lugar Comum Barcarena /PT/ 2008 - photography; FONCA Conaculta / El Centro de la Imagen Mexico City /MX/ 2014 - visual arts, photography

Janiček Martin Phoenix Studios Brighton /UK/ 2005 - music
Villa Waldberta Mnichov /DE/ 2006 - music

Jirát Antonín Czech Centre Stockholm / Kollektivet Livet Stockholm /SE/ 2012 - visual arts

Jislová Štěpánka Czech Centre Sophia /BG/ 2013 - literature

Kacianová Veronika Club Portugues de Artes e Ideias Lisbon / Lugar Comum Barcarena /PT/ 2005 - dance

Kinterová Markéta FONCA Conaculta / El Centro de la Imagen Mexico City /MX/ 2008 - photography

Klyukov Alexey Czech Centre Moscow /RU/ 2012 - visual arts
Czech Centre Bucharest /UA/ 2013 - visual arts, photography

Kolečko Petr Royal Court Theatre London /UK/ 2008
- theatre, literature

Kolmačka Pavel ATI Prague /CZ/ 2013 - literature

Kopecký Václav Czech Centre Brussels /BE/ 2012 -
visual arts, photography

Korpaczewski Igor Club Portugues de Artes e Ideias Lisbon / Lugar Comum Barcarena /PT/ 2007 - visual arts

Kotzmannová Alena FONCA Conaculta / El Centro de la Imagen Mexico City /MX/ 2007 - photography

Křižková Nikola danceUnion London /UK/ 2011 - dance

Langer Radim Czech Centre Bucharest /RO/ 2012 - visual arts

Látalová Bára Czech Centre Brussels / Les Brigittines /BE/ 2014
- dance

Lenerová Tereza danceUnion London /UK/ 2011- choreography

Lhotáková Kristýna Panorama Festival Rio de Janeiro /BR/ 2005 - dance

Linhart Patrik Czech Centre London / Wales Literature Exchange Aberystwyth /UK/ 2014 - literature

Loviška Milan ATI / Meetfactory Prague /CZ/ 2009 - dance, choreography

Maděra Petr Kirjailijatalo Jyväskylä /FI/ 2009 - literature

Malijevský Igor Club Portugues de Artes e Ideias Lisbon /

Lugar Comum Barcarena /PT/ 2007 - visual arts

Malý Radek Villa Decius Krakow /PL/ 2009 - literature

Malý Robert ATI / Meetfactory Prague /CZ/ 2009 - music,
performing arts

Nadaud Pierre Beau Geste Paris / Val de Reuil /FR/ 2006 - dance

Nejtek Michal Club Portugues de Artes e Ideias Lisbon / Lugar
Comum Barcarena /PT/ 2004 - music

Nikl Petr Riocenacontemporanea Tempo Festival Rio de Janeiro
/BR/ 2005 - theatre, visual arts

Nosková Věra Villa Decius Krakow /PL/ 2014 - literature

Ondrašíková Věra Cel.lula Barcelona, Pontós /ES/ 2010 - dance

Pivoňková Barbora Czech Centre Brussels / Contretype /BE/
2012 - visual arts, photography

Popovici Iona Mona Panorama Festival Rio de Janeiro /BR/
2006 - dance; coLABoratorio Rio de Janeiro, Belo Horizonte,
Fortaleza /BR/ 2007 - dance

Sedlecký Zbyněk Czech Centre Bucharest /RO/ 2007 - visual arts

Serranová Mariana Liverpool Biennale /UK/ 2014

- visual arts, curating

Skála František Czech Centre Brussels /BE/ 2013 - visual arts

Skřivánková Iva Czech Centre Brussels / T.A.G. Gallery Brussels
/BE/ 2012 - visual arts, photography

Soukup Ladislav Panorama Festival Rio de Janeiro /BR/ 2005 - dance

Sterec Pavel Czech Centre Bucharest /RO/ 2012 - visual arts,
photography

Střížková Johana FONCA Conaculta / El Centro de la Imagen
Mexico City /MX/ 2013 - visual arts, video art

Svitekova Zdena Beau Geste Paris / Val de Reuil /FR/ 2006 - dance

Svoboda Libor Treasure Hill Artist Village Taipei /TW/ 2011-2012
- visual arts

Svoboda Ivan Czech Centre Bucharest /RO/ 2013 - visual arts,
video art

Šeba Michal Club Portugues de Artes e Ideias Lisbon / Lugar
Comum Barcarena /PT/ 2010 - visual arts; FONCA Conaculta /
El Centro de la Imagen Mexico City /MX/ 2012 - visual arts

Šedá Kateřina PROGR/Zentrum für Kulturproduktion Bern /CH/
2005 - visual arts

Šerých Jan PROGR/Zentrum für Kulturproduktion Bern /CH/
2005-2006 - visual arts

Šloncová Magdaléna Panorama Festival Rio de Janeiro /BR/
2006 - dance; coLABoratorio Rio de Janeiro, Belo Horizonte,
Fortaleza /BR/ 2007 - dance

Štorek Pavel Panorama Festival Rio de Janeiro /BR/ 2007
- dance, curating

Štůralová Lenka OMI International Arts Center /US/ 2013 - music

Tengler Jakub OMI International Arts Center /US/ 2012 - music

Těsnohlídek Jan Kirjailijatalo Jyväskylä /FI/ 2010 - literature

Ther Marek Czech Centre Stockholm / WIP: residence /SE/
2012 - audiovisual art

Thýn Jiří PROGR/Zentrum für Kulturproduktion Bern /CH/
2007 - visual arts; FONCA Conaculta / El Centro de la Imagen
Mexico City /MX/ 2009 - photography

Tučková Kateřina New Orleans /US/ 2013 - literature

Vajd Aleksandra FONCA Conaculta / El Centro de la Imagen
Mexico City /MX/ - 2011 - visual arts, photography

Vaněk Tomáš Camden Arts Centre / The Delfina Studios London
/UK/ 2004 - visual arts

Vičar Jan Schafhof Freising /DE/ 2006 - visual arts

Vokurková Lenka Beau Geste Paris / Val de Reuil /FR/ 2006 - dance

Vrbický Štěpán Czech Centre Bucharest /RO/ 2011 - visual arts

Žižka Tomáš Instituto Francisca de Souza Peixoto Cataguases /BR/
2005 - theatre, visual arts



A list of artists from abroad who participated in residencies in the Czech Republic 2004 – 2014

Agda Bavi Pain /SK/ ATI Prague - 2014 - literature

Altena Marion /NL/ ATI Prague - 2012 - visual arts, literature

Baptista Rosa /PT/ Open Studios programme of the Linhart Foundation Prague - 2007 - visual arts

Barros Gustavo /BR/ ATI Prague - 2006 - dance

Benisi Vanina /FR/ ATI Prague / Festival Festivocea / mamapapa o.s. - 2006 - music

Bolton Owen /CA/ ATI Prague - 2013 - music

Bond Giti /BR/ ATI Prague - 2006 - dance

Brycz Pavel /CZ/ ATI Prague - 2012 - literature

Buejiro Veronica /MX/ ATI Prague - 2012 - visual arts, performing art

Bücher Kaspar /CH/ Open Studios programme of the Linhart Foundation Prague - 2007 - visual arts

Casalonga Nicole /FR/ ATI Prague / Festival Festivocea / mamapapa o.s. - 2006 - music

Clemens Brand Peter /CH/ Open Studios programme of the Linhart Foundation Prague - 2006 - visual arts

Decina Paco /FR/ ATI Prague / S.E.S.T.A / French Institute Prague - 2006 - dance

Delmar Alexander /PT/ Open Studios programme of the Linhart Foundation Prague - 2008 - photography

Deres Kornélia /PL/ ATI Prague - 2014 - literature

Eger Judith /DE/ ATI Prague / mamapapa o.s. - 2006 - multimedia

Forment Ester /ES/ ATI Prague / Meetfactory Prague - 2009 - dance, choreography

Fragoso Nuria /MX/ Open Studios programme of the Linhart Foundation Prague - 2009 - choreography

Gerasimovič Irina /BY/ ATI Prague - 2013 - literature

Gibran Valencia Vanessa /MX/ Open Studios programme of the Linhart Foundation Prague - 2007 - visual arts

Goetsch Daniel /CH/ Halma Project / Prague House of Literature
by German-Language Writers - 2008 - literature

Guerreiro Patricia /PT/ Open Studios programme of the Linhart
Foundation Prague - 2005-2006 - visual arts

Hablák Andrej /SK/ ATI Prague - 2013 - literature

Hanuš Ondřej /CZ/ ATI Prague - 2014 - literature

Heffernan Caitlin /UK/ Open Studios programme of the Linhart
Foundation Prague - 2005 - visual arts

Hernández Angel Aurelio Arreola /MX/ ATI Prague -
2005 - theatre

Hernández Vanessa /MX/ Open Studios programme of the
Linhart Foundation Prague - 2006 - theatre, visual arts

Hoestenbergh Barbara von /BE/ ATI Prague /
Studio Kokovice 4 - 2009 - performing arts

Imreh András /HU/ ATI Prague - 2012 - literature

Kazhdan Yakov /RU/ ATI Prague - 2012 - visual arts

Kempinck Valentina /BE/ ATI Prague / Studio Kokovice 4 -
2009 - performing arts

Kepplová Zuzana /SK/ ATI Prague - 2014 - literature

Kobierski Radosław /PL/ ATI Prague - 2014 - literature

Langenegger Lorenz /CH/ ATI Prague - 2012 - literature

Lima Dani /BR/ ATI Prague / Studio Kokovice 4 - 2005 - dance

Makhélé Caya /FR/ ATI Prague - 2009 - literature

Marecki Piotr /PL/ ATI Prague - 2012 - literature

Mata Judith /ES/ Studio Alt@rt - 2008 - dance

McGeorge Eline /NO/UK/ TI Prague - 2004 - visual arts

Mendes Raquel Open Studios programme of the Linhart
Foundation Prague - 2009 - photography

Mendoza Elizandes Jimena /MX/ ATI Prague -
2013 - visual arts

Mesterházi Mónika /HU/ ATI Prague - 2013 - literature

Migliora Marzia /IT/ TI Prague / National Museum Prague -
2004-2005 - visual arts

Möderndorfer Vinko /SI/ ATI Prague - 2011 - literature

Müller Irina /DE/ KC Zahrada - 2008 - dance

Noyer Omblin /FR/ ATI Prague - 2013 - dance

Nowacka Iwona /PL/ ATI Prague - 2014 - literature

Orzy gnes /HU/ ATI Prague - 2014 - literature

Patricio Tiago /PT/ ATI Prague / Open Studios programme of the Linhart Foundation Prague - 2007 - visual arts, photo, literature

Pellegrini Anne /FR/ ATI Prague / Festival Festivocea / mamapapa o.s. - 2006 - music

Sedal Jn /SK/ ATI Prague / Meetfactory - 2011 - performing arts

Serran Jessica /US/ ATI Prague - 2011 - visual arts

Sighicelli Elisa /IT/ ATI Prague / National Museum Prague - 2005 - visual arts

Skilde Morten /DK/ ATI Prague - 2009 - literature

Surosz Mariusz /PL/ ATI Prague - 2013 - literature

Swings Liesbeth /BE/ ATI Prague / Studio Kokovice 4 - 2009 - performing arts

Van Vlierberghe Iwana /BE/ ATI Prague / Studio Kokovice 4 - 2009 - performing arts

Verdonck Benjamin /BE/ ATI Prague / Studio Kokovice 4 - 2009 - performing arts

Vesel Jindřich /CZ/ ATI Prague - 2014 - literature

Vevar Stefan /SI/ ATI Prague - 2009 - literature

Villagrn Galindo Plinio /MX/ ATI Prague / MeetFactory - 2014 - visual arts

Xiong Yaodong (pseud. Long Dong) /CN/ ATI Prague - 2011 - literature

Zulai Macias Osorno /BR/ Open Studios programme of the Linhart Foundation Prague - 2008 - dance

Žuchov Svetlana /SK/ ATI Prague - 2012 - literature

4. Residency locations

MeetFactory Prague, Photo: © Tomáš Souček

Egon Schiele Art Centre (ESAC), Český Krumlov, Czech Republic

The Egon Schiele Art Centre was founded by Serge Sabarský (1912–1996), an art collector and expert in expressionism, Gerwald Sonnberger (1950–2001), past director of the Museum of Modern Art in Passau, the E. Schiele Foundation, and Neue Galerie New York, and Hana Jirmusová, director of ESAC. It was set up in a historic complex of buildings previously occupied by a brewery from the 16th century, reconstructed in November 1993, and made accessible to the public. The unique international cultural centre located in one of the most beautiful Renaissance cities in Europe presents exhibitions and documents the life and work of Egon Schiele, and in cooperation with the Ministry of Culture of the Czech Republic it also offers study and work residencies to young students from Eastern and Western Europe in its generous studio spaces.

www.schieleartcentrum.cz

Other residency locations in the Czech Republic

MeetFactory, Prague

The international residency programme at MeetFactory was established in 2007 and is the largest programme of its kind in the Czech Republic. A non-profit international contemporary art centre, MeetFactory has fifteen studios and each year offers these spaces for use to more than thirty invited visual artists, curators, musicians, theatre directors, and writers. It encourages artists to take part in MeetFactory's programme (e.g. open studios, presentations, Public House, Museum Night) and the activities in its three exhibition spaces (e.g. exhibitions, performances, guided tours), and to become involved in the Czech and European art scenes. *www.meetfactory.cz*

FUTURA centre for contemporary art, Prague

This private non-profit organisation runs two exhibition spaces devoted to contemporary art, a residency programme in Prague, a Renaissance chateau in Třebešice in the district of Kutná Hora that houses a collection of Czech and foreign contemporary art, and a residency programme in a two-storey building in Brooklyn, New York, in the United States. FUTURA Gallery occupies a three-storey building with 1000 m2 of floor space in Prague's Smíchov District. Since 2003 group and solo exhibitions in the gallery's spaces have presented work by many well-known and internationally respected artists from the Czech Republic and abroad.

www.futuraproject.cz

Residency locations abroad and long-term partners of the AiR programme

Czech Centres

The Czech Centres work to promote Czech culture on the international stage and to strengthen the image of the Czech Republic in the world. They are contributory organisations of the Czech Ministry of Foreign Affairs and are established to promote the Czech Republic abroad. The Arts Institute collaborates with Czech Centres, particularly in Bucharest, Brussels, Stockholm, and London, on organising creative residencies in the fields of the visual arts, photography, and literature.

www.czechcentres.cz

Fondo Nacional para la Cultura y las Artes (FONCA) Mexico City

This national fund for culture and the arts was established in 1989 with the objective of supporting and stimulating artistic creativity in all its forms. In connection with a residency exchange initiative for artists launched between Mexico and the United States, a residency programme was set up in 1992 in which, as well as the Czech Republic, Germany, Argentina, Austria, Canada, Chile, Columbia, France, and the province of Quebec participate.

<http://fonca.conaculta.gob.mx>



Residency studio at ESAC,
Český Krumlov, Photo: © archive ESAC

The International Visegrad Fund – Prague, Bratislava, Budapest, Krakow

The Visegrad residency programme for writers was established in 2012 by the International Visegrad Fund. The programme organises residencies and literary events for writers of prose, non-fiction, and poetry, and for translators and journalists from Visegrad countries (Czech Republic, Slovakia, Hungary, and Poland). This programme supports the creativity and mobility of talented writers and works to develop a platform for the exchange of information and for the development and promotion of literature in the Visegrad countries of Central Europe. Organisations collaborating in the programme include the International Visegrad Fund, Villa Decius in Poland, the Arts Institute in the Czech Republic, the Centre for Information on Literature in Slovakia, and Petöfi Literary Museum in Hungary.

www.visegradfund.org

HALMA

From 2006 to 2013 the Arts and Theatre Institute was a member of the European HALMA network consisting of 26 literary centres across Europe. HALMA brought together European literary centres, facilitated intercultural exchanges, and provided participants working in the field of literature (writers, translators, and others) with the opportunity to experience the diversity of different cultures. The HALMA network created structures for dialogue between European regions. The network and project came to an end in 2013.

www.halma-network.eu

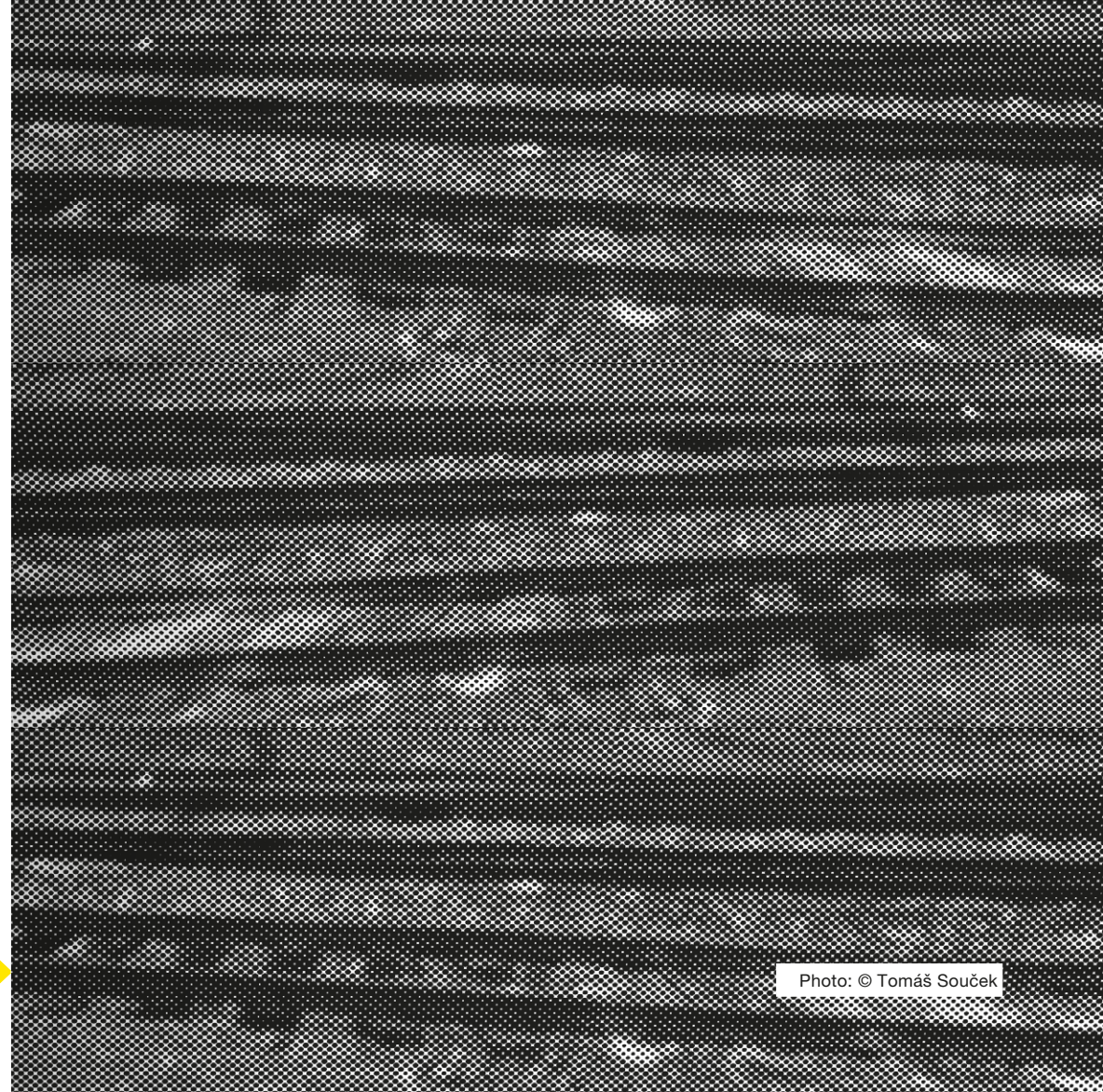

Photo: © Tomáš Souček

10 AiR

**Ten Years of the Arts Institute's
Artist-in-Residence Programme
2004 – 2014**

Compiled by: Romana Štorková Maliti

Written by: Markéta Černá, Romana Štorková Maliti

Edited by: Markéta Černá

Supervisor: Eva Žáková

Translation: Robin Cassling

Cover design: © Kryštof Doležal with photo by © Ivan Svoboda

Graphic design and typesetting by: © Kryštof Doležal

Published by: Arts and Theatre Institute in Prague 2015

This is the ATI's 682nd publication

1st edition

Not for sale

ISBN 978-80-7008-344-4 (pb)

ISBN 978-80-7008-345-1 (pdf)



**MINISTERSTVO
KULTURY**

institutumeni.cz
culturenet.cz